

# TGLA1 Series Button Switch



## 1 Overview

TGLA1 Series Button Switches are suitable for the AC 50Hz/60Hz circuit control system with voltage up to 400V, DC voltage up to 230V for control of magnetic starters, contactors, relays and other electrical lines. The button with indicator light is also suitable for occasions with light signal indication.

## 2 Type Designation

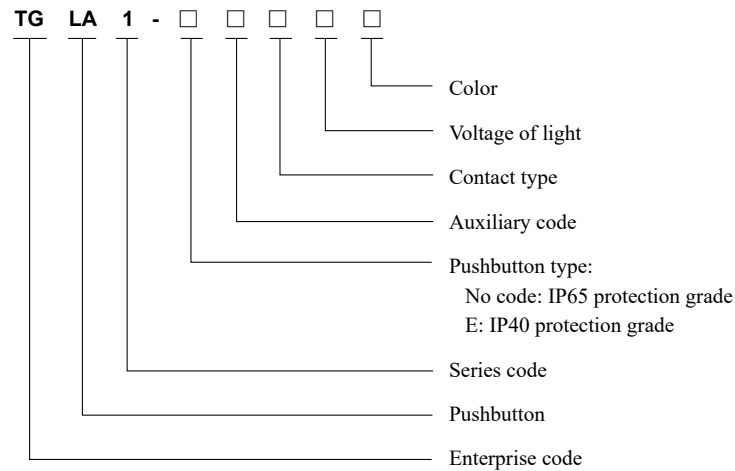

## 3 Technical Parameters

3.1 Ratings and various performances see Table 1;

3.2 Model, specifications and type see Table 2;

3.3 The rated limit short-circuit current is 1000A, and the model of SCPD used is RT19-32.

Table 1

Rated insulation voltage $U_i$ (V)	690			
Rated impulse withstand voltage ( $U_{imp}$ )(kV)	4			
Resistive current $I_{th}$ (A)	10			
Rated working voltage $U_e$ (V)		400	230	110
Rated working current $I_e$ (A)	AC-15	1.9	3	/
	DC-13	/	0.3	0.6
LED lamp voltage (V)	AC/DC	6、12、24、48、110、220		AC 380
Contact resistance	$\leq 50m\Omega$			
Mechanical life	Flat button, high button, mushroom button: 3 million times Knob, key button, E-stop button, self-lock button: 100,000 times			
Electrical life	AC-15: 600,000 times DC-13: 300,000 times			
Protection grade	Common type: IP65 (Other button), IP40 (key button): E type: IP40			

## TGLA1 Series Button Switch

Table 2

Pushbutton type	Auxiliary code		Contact type	Lamp voltage	Color		
P : Flat button ZP : Self-locking flat button G : High button ZG: Self-lock high button	—	—	1: 1NC 2: 1NO 3: 2NC 4: 2NO 5: 1NO+1NC	AC/DC6V AC/DC12V AC/DC24V AC/DC48V AC/DC110V AC/DC220V AC380V	White Green Red Yellow Blue Black		
M: Mushroom head self-reset button	4:φ40 6:φ60	—					
DX: Short-handle knob CX: Long-handle knob	21: Two-position lock 22: Two-position reset 31: Three-position lock 32: Three-position reset 33: Three-position left lock and right reset 34: Three-position left reset and right lock	—					
DP : Illuminated flat button DZP : Illuminated self-lock flat button DG : Illuminated high button DZG: Illuminated self-locking high button	—	—					
DM: Illuminated mushroom head self-reset button with light	4:φ40 6:φ60	—					
DDX: Illuminated short-handle knob DCX: Illuminated long-handle knob	21: Two-position lock 22: Two-position reset 31: Three-position lock 32: Three-position reset 33: Three-position left lock and right reset 34: Three-position left and right lock	—					
YE: key button	21: Two-position lock 22: Two-position reset	0: Two-position lock, two-position pull out 1: Two-position reset, middle pull out 2: Two-position lock, middle pull out					
	31: Three-position lock 32: Three-position reset 33: Three-position left lock and right reset 34: Three-position left and right lock	0: Three-position lock, three-position pull out 1: Three-position reset, middle pull out 2: Three-position lock, left/middle pull out 3: Three-position lock, right/middle pull out 4: Three-position lock, middle pull out 5: Three-position left lock, right reset, left/middle pull out 6: Three-position left lock, right recovery, middle pull out 7: Three-position left and right lock center/right pull out 8: Three-position left and right lock, middle pull out					
XF: Rotate to release E-stop button	3: φ30 4: φ40 6: φ60	—				—	Red
C:Accessories	10: Normally open contact group 01: Normally closed contact group	—				—	—

Note: 1. The type of button in the table is IP65 protection grade. If IP40 protection grade is required, it is necessary to put "E" after the type of button.

2. The key button protection grade: IP40.

## TGLA1 Series Button Switch

### 4 Operating Conditions

#### 4.1 Normal operation condition

4.1.1 Ambient air temperature:  $-25^{\circ}\text{C}\sim+50^{\circ}\text{C}$ ; the average temperature within 24h does not exceed  $+45^{\circ}\text{C}$ ; the altitude of the installation site does not exceed 2,000 meters.

#### 4.1.3 Atmosphere conditions

4.1.3.1 Humidity: When the maximum temperature is  $+50^{\circ}\text{C}$ , the relative humidity of the air does not exceed 50%; higher relative humidity is allowed at lower temperatures.

For example: up to 90% at  $20^{\circ}\text{C}$ ; special measures should be taken for the occasional condensation due to temperature changes.

4.1.4 Pollution degree: 3.

#### 4.2 Installation conditions

4.2.1 Used in a place without non-explosive medium that there is no enough gas and conductive dust to cause corrosion to metal and damage to the insulation;

4.2.2 Used in places with rain and snow prevention equipment provided not full of water vapor;

4.2.3 Used in a place where there is no significant shaking, shock and vibration;

4.2.4 Installation category: Class II.

### 5 Structure Features

5.1 All contacts have the dual functions of switching circuit and self-cleaning, and the reliability of contacts can still be guaranteed under low voltage and low current;

5.2 The normal open and normal closed contact groups are independent of each other; they can be combined as required for convenient replacement.

5.3 The concealed wiring terminal is used, safer and more reliable.

### 6 Outline and Installation Dimensions

6.1 The installation size of this series of products is  $\Phi 22.3^{+0.4}_0$ . When installation, insert the head of button into the mounting hole from the front of panel, then insert the tightening nut at the back of the panel (panel thickness ranged 1mm to 6mm) (note: the installation torque is controlled  $2.2\text{N}\cdot\text{m}\pm 0.2\text{N}\cdot\text{m}$ ), install the middle set after fastening nut, and finally close the switch components or lamp holder directly without any tools required.

6.2 When wiring, first loosen the screw with a screwdriver, then connect the wire, and finally tighten the screws (the tightening torque ranged  $0.8\text{N}\cdot\text{m}\sim 1\text{N}\cdot\text{m}$ ). After installation, press the button and check for blockage and whether the switch elements are fully inserted. If found any abnormality, please contact our company for solving problems in time.

#### 6.3 Installation and removal method

Installation method:

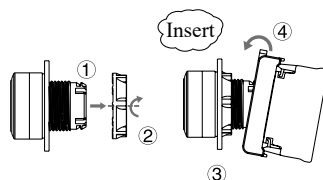

Removal method:

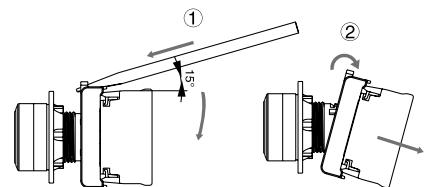

## TGLA1 Series Button Switch

6.4 When several buttons are installed on the control panel side by side on the control panel, the distance between the center line of the buttons in the same row and the center line of each row of buttons shall not be less than the values listed in the following table.

Table 3

Name	size	
	a	b
General buttons, illuminated buttons, short-handle knobs, key buttons	30.5	60
φ40mm mushroom button, long-handle knob, φ30mm E-stop button, φ40mm E-stop button	45	60
φ60mm mushroom button, φ60mm E-stop button	65	70

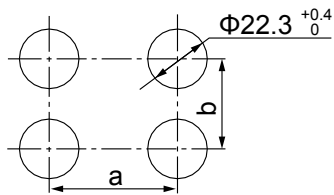

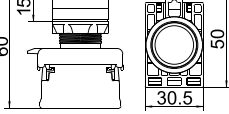

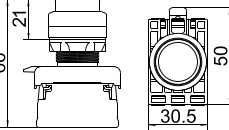

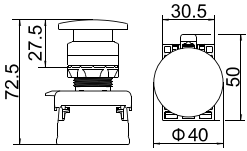

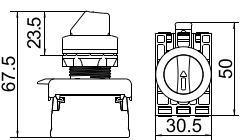

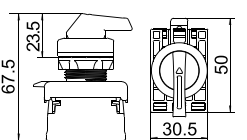

Table 4

Name	Variety	Model specification	Auxiliary code	LED lamp voltage	color	Dimensions
Flat button 	General	TGLA1-P/ZP □□	/	/	Lighting: White Green Red Yellow Blue  Without lighting: White Green Red Yellow Blue Black	
		TGLA1-DP/DZP □□				
High button 	General	TGLA1-G/ZG □□	/	/	Lighting: White Green Red Yellow Blue  Without lighting: White Green Red Yellow Blue Black	
		TGLA1-DG/DZG □□				



## TGLA1 Series Button Switch

Table 4, continued

Name	Variety	Model specification	Auxiliary code	LED lamp voltage	color	Dimensions
Mushroom head self-reset button  	General	TGLA1-M □□	/	/	Lighting: White Green Red Yellow Blue  Without lighting: White Green Red Yellow Blue Black	
		TGLA1-DM □□				
Short-handle knob  	Knob	TGLA1-DX □□	21: Two-position lock 22: Two-position reset 31: Three-position lock 32: Three-position reset 33: Three-position left lock and right reset 34: Three-position left and right lock	/	Lighting: White Green Red Yellow Blue  Without lighting: White Green Red Yellow Blue Black	
		TGLA1-DDX □□				
Long-handle knob  	Knob	TGLA1-CX □□	21: Two-position lock 22: Two-position reset 31: Three-position lock 32: Three-position reset 33: Three-position left lock and right reset 34: Three-position left and right lock	/	Lighting: White Green Red Yellow Blue  Without lighting: White Green Red Yellow Blue Black	
		TGLA1-DCX □□				

## TGLA1 Series Button Switch

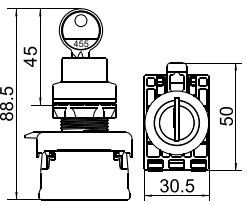
Table 4, continued

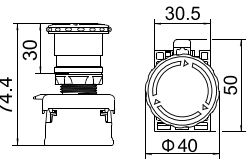
Name	Variety	Model specification	Auxiliary code	LED lamp voltage	color	Dimensions
Key button  	Key button	TGLA1-YE □ □	21: Two-position lock 0: Two-position lock Two-position pull out 1: Two-position reset Middle pull out 2: Two-position lock Middle pull out  31: Three-position lock 0: Three position lock Three-position pull out 1: Three-position reset Middle pull out 2: Three-position lock Left/middle pull out 3: Three position lock Right/middle pull out 4: Three position lock Middle pull out 5: Three-position left lock 33: Three-position left lock and right reset Right reset Left/middle pull out 6: Three-position left lock 34: Three-position left and right lock Right reset, middle pull out 7: Three-digit left reset Right lock center / right pull out 8: Three-position left reset Right lock, middle pull out	/	/	
Rotate to release E-stop button  	Rotate to release E-stop button	TGLA1-XF □ □	3: $\Phi 30\text{mm}$ 4: $\Phi 40\text{mm}$ 6: $\Phi 60\text{mm}$	/	Red	

### 7 Ordering Notice

Please specify the following items when ordering the product from our company:

- Product name and model;
- Order quantity.

Order example:

AC/DC 220V 1 Normally Close +1 Normally Open Illuminated red flat buttons, 100 pcs:  
 TGLA1-DP5 AC/DC220V red 100 pcs.